

Klassisk design

Annelise Bjørner

Dørgreb og tilbehør





Annelise Bjørner

Er uddannet fra Kunstakademiets Arkitektskole i 1957.

I 1972 blev Annelise Bjørner-dørgrebet lanceret, som var en del af hendes elevarbejde fra designlinjen på Kunstakademiet.

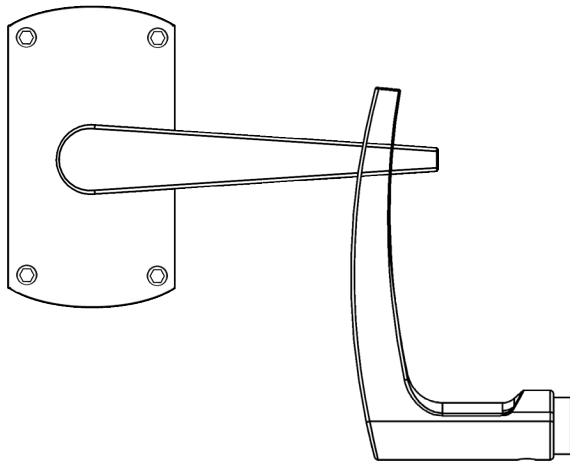

Poleret messing.

Dørgreb og tilbehør leveres i poleret ubehandlet messing.

Dørgreb til ind- og udvendige døre



Dørgreb med rosetter
Ø50-C30
Leveres i sæt inkl. M4 skruer
12.4117.01.030

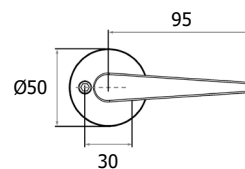

Dørgreb med rosetter
45 x 75mm.
Leveres i sæt inkl. M4 skruer
12.4118.01.999

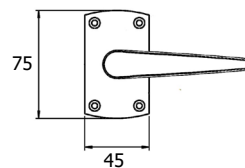

Dørgreb uden rosetter
til langskilte.
12.4116.01.011

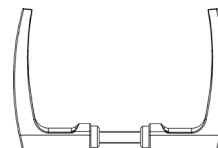

Tilbehør til indvendige døre



Nøgleskilte Ø50-C27
Leveres i sæt inkl. M4 skruer
0010.013233

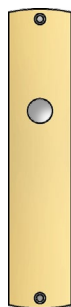
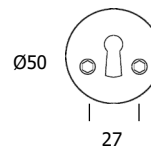

Langskilte 45 x 220mm.
Leveres i par inkl. skruer

0010.013750 = AA
0010.013753 = BA

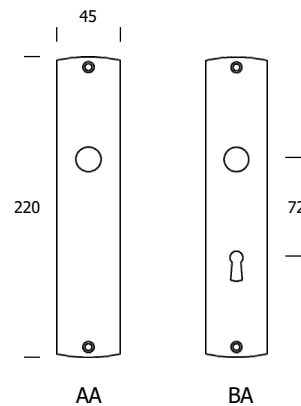

Tilbehør til udvendige døre



Cylinderring
Leveres i stk. eks. skruer
0010.014106 - 6mm
0010.014108 - 8mm
0010.014111 - 11mm
0010.014113 - 13mm
0010.014116 - 16mm
0010.014118 - 18mm
0010.014121 - 21mm



Cylinderring - Rokoko
Leveres i stk. eks. skruer
0010.014306 - 6mm
0010.014308 - 8mm
0010.014311 - 11mm
0010.014313 - 13mm
0010.014316 - 16mm
0010.014318 - 18mm
0010.014321 - 21mm



Vrider
Ø50x2mm-C30
Leveres i stk. eks. skruer
0010.013455



Knækskruer
M5 x 110
15.2981.00.751

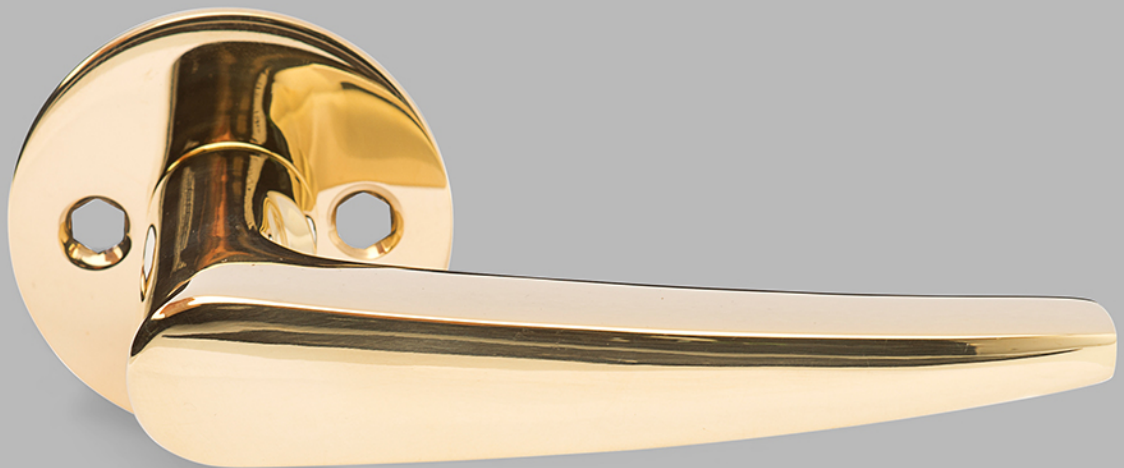

Funktioner

Indvendige døre

F-00

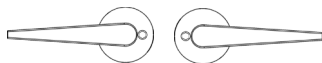

F-02

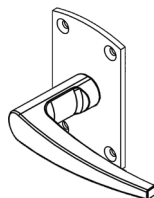
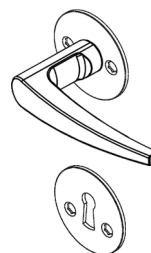
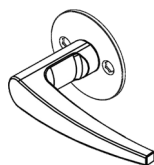
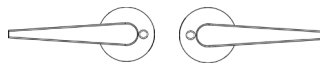

Funktioner

Indvendige døre

F-00L

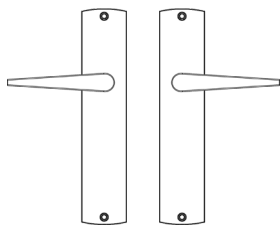

F-02L

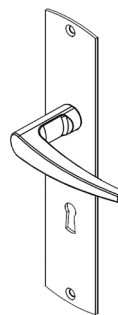
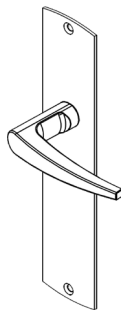
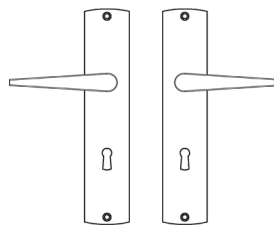

Funktioner

Udvendige døre

F-11

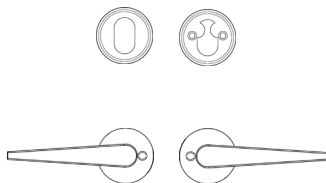

Cylinderring ind- og udvendig

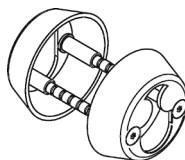

F-12

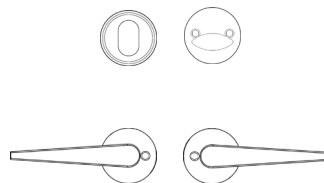

Cylinderring og vrider

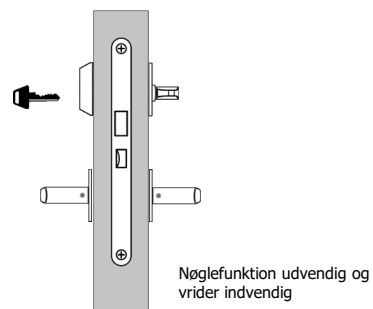
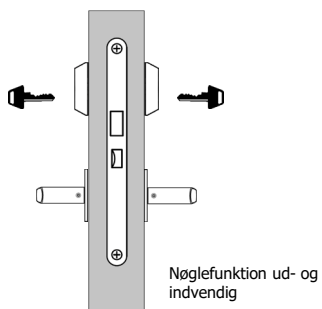
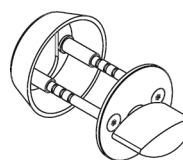



PBV-Solution
+45-24231524
info@pvtrading.dk